

Original Research Paper

# Design and Fabrication of Arduino-Based Automated Cradle Rocking and Moisture Detection Mechanism

Canute Sherwin, Raju K., Manish V. K., Milton Fernandis, Ashwiji Shetty and Johan Samuel

Department of Mechanical Engineering, St Joseph Engineering College, India

## Article history

Received: 12-07-2022

Revised: 07-08-2022

Accepted: 08-08-2022

Corresponding Author:

Canute Sherwin

Department of Mechanical

Engineering, St Joseph

Engineering College, India

Email: cscanutesherwin8@gmail.com

**Abstract:** A new, inexpensive domestic electronic cradle that can compete with current imported, expensive models has been a long-time need. This study describes the design and implementation of a new indigenous low-cost E-Baby Cradle that swings automatically when the baby cries. The cry analyzing system recognizes the sound of a baby's cry and swings the cradle appropriately until the baby stops crying. According to the user's needs, the cradle's speed can be adjusted. The cradle also has an integrated alarm that signals two situations: First, when the mattress is wet, which is a crucial factor in maintaining the baby's hygienic state; second, when the infant continues to cry for a prolonged period, which suggests that the baby requires attention. This method enables nurses and parents to care for infants without having to physically touch them.

**Keywords:** Cradle, Sensors, Detection, Cry Analyzer

## Introduction

It has become extremely challenging for parents and nannies to find adequate time to care for their children in the current busy lifestyle and commitments. Sometimes parents also can't afford to pay for a nanny or enroll their kids in daycare while they work. From studies, it is observed that giving babies a gentle, rhythmic movement in the cradle, causes them to cease crying or go asleep.

An innovative answer to this issue is the E-Cradle that has been proposed. The proposed design includes a circuit installed along the cradle that detects the sound intensity of the baby's cry and takes the appropriate action in response.

E-cradles are made to assist parents and even housewives in caring for their children while doing domestic chores without having to physically attend to them.

The present design aims to:

- Swing the cradle automatically when a baby cries
- Stop swinging if the infant stops crying before the two minutes
- Sound an alarm if the baby cries for more than two minutes, to alert the parents
- Sound an alert if the mattress becomes wet

Goyal and Kumar (2013) developed an electronic cradle with a cry analyzing device that hears the baby's cry and swings the cradle till the child stops crying as a result (Goyal and Kumar, 2013).

Marie (1973) created a crib with an autonomous rocking feature. The invention discloses an apparatus for automatically rocking a baby to sleep safely and is easy to operate, service, and maintain. A spring-loaded mechanical motor is used for the swing of the cradle. The locking and actuating arms can be operated under the biasing force of a spring in conjunction with the gear once the crib has been manually tilted in one direction and released. As a result, the spring-loaded motor starts to run and the lever attached to the crib oscillates before stopping when even the smallest amount of resistance is encountered (Marie, 1973).

Palaskar *et al.* (2015) designed an automatic baby cradle system that monitors factors including infant cries, surroundings temperature, and moisture levels. Parents can access this data utilizing the cloud to take the appropriate management actions (Palaskar *et al.*, 2015).

Bhatnagar *et al.* (2020) designed a cradle that automatically swings when the baby cries. If the infant stops crying before two minutes have passed, the cradle will automatically stop swinging after three minutes. Additionally, it sounds like an alarm when the mattress becomes wet and an alarm if the infant cries for longer than the predetermined two minutes (Bhatnagar *et al.*, 2020).

Shrikant *et al.* (2011) developed a cradle design with an SMS module enclosure function such as camera surveillance, automatic cradle swinging in response to baby's cries, detecting moisture in the bed, and monitoring the baby's presence in the cradle (Shrikant *et al.*, 2011).

Sneha *et al.* (2007) designed an e-baby cradle with soft music. When the bed becomes wet and hyperthermia conditions were simulated individually and the developed product was able to send the message to the user (Sneha *et al.*, 2007).

Natheera *et al.* (2003) believed that as opposed to the market's standard cradles, which swing from left to right, their framework works from top to bottom. The cradle swings automatically from north to south thanks to the microphone module. If the bed in the cradle is wet or not, the wet sensor returns a Boolean value of true or false. When a baby is experiencing an abnormal state, the video of the child is shown on the integrated camera module (Natheera *et al.*, 2003).

Amol Srivastava and Yashaswini (2019) designed a Smart Cradle, which employs PIR sensors to keep an eye on the infant, a noise sensor to identify when the youngster is crying, and an autonomous cradle swing to calm the child. Additionally, a moisture sensor is included to keep the child's hygiene up to par (Amol Srivastava and Yashaswini, 2019).

#### Patent Search

#### Intelligent Baby Cradle, CN104352113A, 2015-02-18

The utility model discloses a kind of intelligent bassinet, comprising a bedstead, cradle, signal acquiring system, control system, and executive system, also comprise the mosquito net be arranged on the cradle, the described cradle is connected to the bearing holder (housing, cover) of bedstead by a ball bearing, and the temperature-dropping fan is fixed on the bedstead of cradle side; Described executive system comprises music player, motor and abnormal alarm device, the described music player is arranged on bedstead, music player is connected with the output of sound playing circuit, music player is provided with time delay flat unit, and this time delay flat unit is connected with the sound volume regulation unit in the music player.

#### Infant Monitor System and Method, US20150009029A1, 2015-01-08

To create better notices and/or reduce the instances where the client device needs to be disturbed, various patterns of behavior for the child inhabiting the crib and/or the user's response thereto may be analyzed. Additionally, a variation from a pattern of behavior may be discovered or acquired. A processor may notice a departure from normal sleeping behavior and notify the client's device.

#### Dual Arm Child Motion Device, US9861210b2, 2015-09-09

A cantilevered child support component pivotally mounted to the gliding swing mechanism is part of a child motion device that also includes a support frame, a frame hub connected to the support frame, a gliding swing mechanism, and the frame hub.

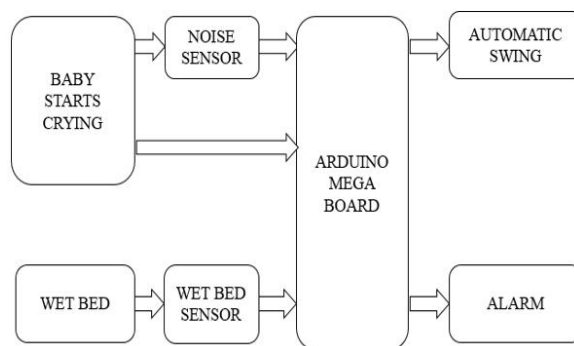

Fig. 1: Block diagram of Methodology

## Materials and Methods

When the baby starts crying, the noise sensor detects the sound of the baby crying and sends a signal to the Arduino Mega Board, which then sends signals to the motor for the swing of the cradle.

In the Wet Bed Sensing system, a wet bed sensor is placed on the bed when the baby wets the bed the sensor detects the water content and signals to the Arduino Mega Board, which then sends signals to the Buzzer which acts as the alarm, hence warning the parents about the wet bed.

Figure 1 represents the block diagram of proposed method comprising of principal parts and functions.

### Construction

#### Electronic Components

1. Arduino UNO- ATmega328P
2. Lithium-Ion battery – 12V, 75AH Deep Cycle
3. Buzzer- 95 DB
4. Soil moisture sensor- REES52
5. Wiper motor- 12V, 0.9A, 41 RPM
6. Sound sensor- 20-110 DB, 12 Bit ADC resolution.
7. Relay module- 1 Channel, 5V

### Fabrication

The frame of the cradle, connecting rod and stand is fabricated using (locally available) Aluminum material. Different fabrication techniques used for developing the model are explained below.

#### Hacksaw Cutting

Cutting smaller-diameter or thin-walled material that requires precise tolerances can be done with high-precision hack sawing. For the present project hacksaw cutting was done on frames of the cradle.

#### Arc Welding

Inert tungsten, a non-consumable tungsten electrode is used in the gas welding technique, also known as gas

tungsten arc welding, to create the weld. Tungsten inert gas welding was applied for getting the required welds.

### Sanding and Painting

Aluminum oxide sandpapers were used to give a smooth finish to the fabricated product and a protective coat was applied.

Dimensions of the model is represented in Fig. 2 and 3D model with placement of critical components are displayed in Fig. 3 and 4.

#### 2D Sketch

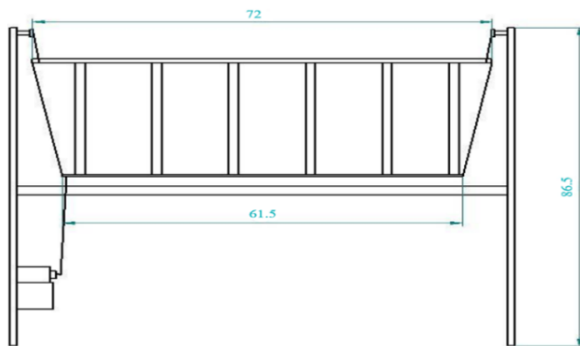

Fig. 2: 2D Sketch of the project \*All dimensions are in cm

#### 3D Modelling

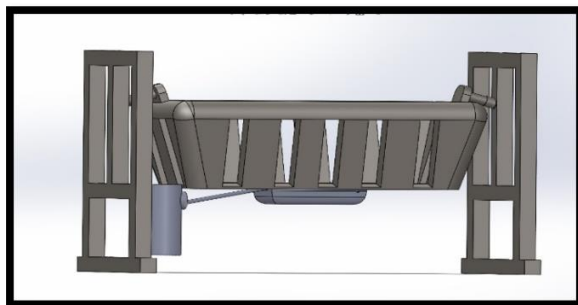

Fig. 3: 3D Model of the project

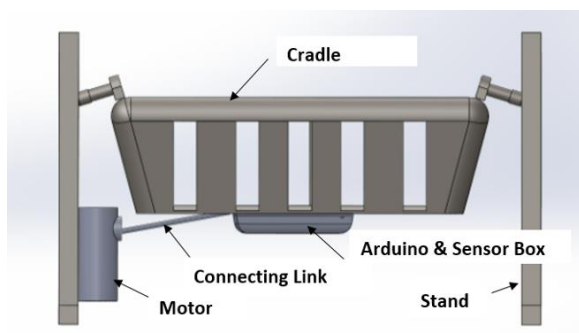

Fig. 4: Critical Components

### Electronic Circuits

The automatic swing circuit includes a mic that is connected to the Arduino board and a 5V relay that acts as a switch to turn the motor on and off. When the baby starts crying the microphone receives the input and gives a signal to the Arduino board which in turn triggers the relay to turn on the wiper motor which has a link connected to the cradle, that will swing the cradle in a rocking motion. Figure 5 displays the circuit connections for automatic swing of the cradle.

The wet bed sensing system uses a soil moisture sensor to detect that the baby had wet the bed, the soil moisture sensor detects the wetness and then gives a signal to the Arduino board, the Arduino board then triggers the buzzer connected to it which then sounds the alarm, to notify the parents that the baby has wet the bed. Circuit connections for wet bed sensing system is represented in Fig. 6.

Detailed working procedure of the model is displayed in the form of a flowchart in Fig. 7.

#### Circuit Diagram for Automatic Swing of the Cradle

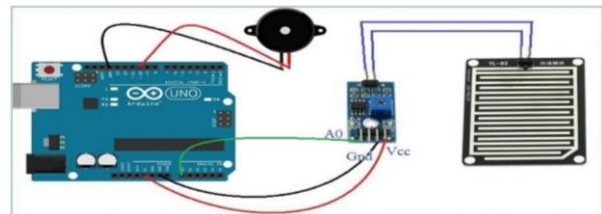

Fig. 5: Circuit diagram for automatic swing

#### Circuit Diagram for Wet Bed Sensing System

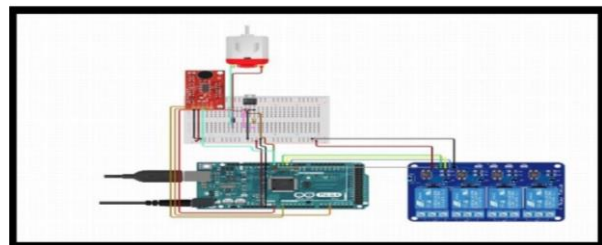

Fig. 6: Circuit diagram of wet bed sensor

Table 1: Baby Cry Samples

Samples	Baby Boy (DB)	Baby Girl (DB)
1	22	34
2	24	31
3	26	35
4	27	33

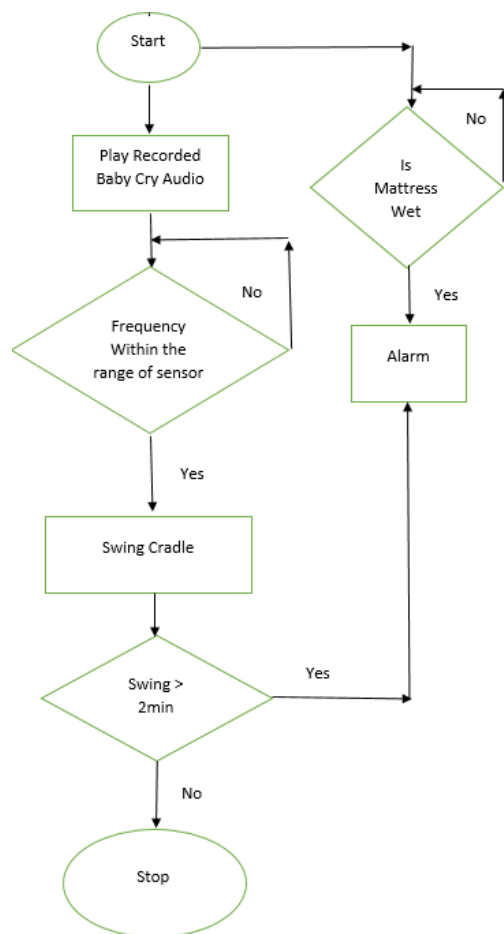

Fig. 7: Flowchart

## Results and Discussion

Various voice samples of baby cries were collected and tested with the present design by playing the recordings and checking the response. The cry voice samples tested are provided in Table 1.

Since all the cry samples collected were within the range of the voice sensor used, the present model responded to the baby's cry and succeeded in swinging. When the crying voice was played for more than 2 min alarm was activated.

The moisture sensor also responded positively when 10, 15, 20 and 25 mL water was poured onto the mattress at a distance of 30 mm radius around the sensor.

## Conclusion

In the present study, an intelligent baby cradle system is developed. The cradle could detect the cry of the baby and initiate a cradle swing. Additionally, when the mattress is wet, the developed device can send an alert to the parents via an alarm. This project emphasizes providing ease for the caring & safety of infants and

reducing the work of the parents. This Project can be used to minimize the workload of nurses in hospitals.

The individual components were put together and tested to make sure they would function well as per the design.

The automatic swing of the cradle was successful by using the motor and battery. The swing of the bed utilizing the baby cry is controlled using Arduino Board, Noise Sensor, and Relay Module.

In the simulation, the alarm by the Buzzer shows that the infant has urinated. As a result, when the circuit is complete, the Arduino activates and the Buzzer receives power, alerting the parents.

## Acknowledgment

The design and development of model was executed with the guidance of staff members of Tech Graylogix Pvt. Ltd., Mangalore, India.

## Funding Information

Received a grant of Rs 8000 from the Karnataka State Council for Science and Technology (KSCST).

## Author's Contributions

**Canute Sherwin:** Drafted of the article.

**Raju K.:** Critical revision of the article.

**Manish V. K.:** Conception of the idea of designed.

**Milton Fernandis:** Design and analysis.

**Ashwij Shetty:** Acquisition of data.

**Johan Samuel:** Interpretation of data and designed.

## Ethics

This article is original and contains unpublished material. The corresponding author confirms that all of the other authors have read and approved the manuscript and no ethical issues involved.

## References

- Amol Srivastava, B. E., & Yashaswini, Sindhu K., (2019). Smart Cradle with PIR sensors, *International Journal of Innovative Technology and Exploring Engineering* 8(9), 2764-2769.
- Bhatnagar, N., Shingal, K., Saxena, A., Tiwari, N., Bhatnagar, S., & Kumar, S. (2020). Automatic Swinging Cradle, *Imperial Journal of Interdisciplinary Research (IJIR)*, Vol-2, Issue-6, pp. 328-333.
- Goyal, M., & Kumar, D. (2013). Automatic E-baby cradle swing based on baby cry. *International Journal of Computers and Applications*, 71(21), 39-43.
- Marie, h. (1973). Crib adopted to rock automatically, *International Conference on Research and Innovations in Science*, Vol. 1, 2017, 226-232.

- Natheera, N. L. Visakan, M. & Vivekkumar. (2003). The Cradle swings Top to Bottom instead of Left to Right, *International Journal of Advanced Research in Computer and Communication Engineering*, 10(5), 370-375.
- Palaskar, R., Pandey, S., Telang, A., Wagh, A., & Kagalkar, R. M. (2015). Automatic monitoring and swinging the baby cradle for infant care. *International Journal of Advanced Research in Computer and Communication Engineering*, 4(12), 187-189.
- Shrikant, P. Ramya, G., & Thomas P. (2011). Cradle with Camera & Automatic Swinging Cradle, *International Journal of Research in Advent Technology*, 7(6), pp 191-194.
- Sneha, S. K., Rejani, S., & Anju, k., (2007). E-Cradle with soft music, *International Research Journal of Engineering and Technology (IRJET)*, 6(5), pp. 2074-2080.