

Original Research Paper

# Predictive Analysis of BMI and Liver Size on Kidney Function in Young Mexican American Population

<sup>1</sup>Orlando Patricio, <sup>2</sup>Rohitha Goonatilake, <sup>3</sup>Fernando G. Quintana, <sup>2</sup>Hongwei Wang and <sup>4</sup>Francisco Cervantes-Gonzalez

<sup>1</sup>Department of Natural Sciences, Laredo College, United States

<sup>2</sup>Department of Mathematics and Physics, Texas A&M International University, United States

<sup>3</sup>Department of Biology and Chemistry, Texas A&M International University, United States

<sup>4</sup>Laredo Pediatrics and Neonatology Clinic, United States

## Article history

Received: 15-04-2022

Revised: 15-07-2022

Accepted: 26-07-2022

## Corresponding Author:

Hongwei Wang

Department of Mathematics and Physics, Texas A&M International University, United States

Email: hongwei.wang@tamui.edu

**Abstract:** This study aimed to determine the probability of fatty liver, hepatomegaly, and liver size  $\geq 2SD$  with age in each category of BMI percentile. It also aimed to investigate the relationship between GFR, BMI percentile, liver size, Blood Pressure (BP), and right kidney volume among overweight and obese boys and girls and to identify the predictors of GFR. 763 records of boys and girls visiting a pediatric clinic in South Texas from 2003 to 2018 were assessed. Statistical analyses such as linear regression, binary logistic regression, cubic estimation, path analysis, and factor analysis were performed. It was found that among all the BMI percentile categories, boys have larger liver sizes than girls. Obese boys and girls have the largest liver size than overweight boys and girls followed by normal (robust) and underweight (slim) boys and girls. As the BMI percentile increases, the probability of fatty liver, hepatomegaly, and liver size  $\geq 2SD$  increases. As the BMI percentile increases, decreased kidney function prevalence increases in the young Mexican American population. Decreased kidney function is also affected by liver enlargement and increased systolic blood pressure. Obese boys' and girls' kidney function start to drop at age 7.755 while overweight boys' and girls' start to fall at age 9.185. The exponential trends in the probabilities between liver size and age indicate that overweight and obese boys and girls are at higher risk for fatty and enlarged liver. Overweight and obese boys and girls have reduced kidney function as indicated by their decreasing GFR. High BMI percentile, increased liver size, and increased systolic blood pressure are precursors (predictors) to decreased kidney function.

**Keywords:** BMI, Obesity, Liver Size, Kidney Function, GFR, Blood Pressure and Predictive Analysis

## Introduction

Current research shows an alarming increase in obesity in the United States and the European region. It also reveals that obesity has detrimental effects on liver and kidney function (Kataoka *et al.*, 2012; Quintana *et al.*, 2018a). Chronic Kidney Disease (CKD) affects the individual's quality of life (Kataoka *et al.*, 2012), and has become a big concern in health conditions, which might cause negative effects on people's daily activities and work (Kataoka *et al.*, 2012; Cohen *et al.*, 2016; Nuttall, 2015; Wang *et al.*, 2008). With the prevalence of obesity among the young population, the US Department of Health and Human Services (DHHS) must focus on its adverse effects on the liver (Quintana *et al.*, 2018b) and kidney function

(Kataoka *et al.*, 2012; Kitsos *et al.*, 2018) to eventually find possible solutions for this health issue (Consultation, 2004; Nuttall, 2015; Wang *et al.*, 2008) or develop strategies in the prevention and management of overweight and obese young Americans.

Recent studies indicate overweight and obesity (Kataoka *et al.*, 2012; Kitsos *et al.*, 2018; Cohen *et al.*, 2016; Lu *et al.*, 2015; Wang *et al.*, 2008) with a high prevalence of hypertension (Khan *et al.*, 2018; Wang *et al.*, 2008) are risk factors for End-Stage Renal Disease (ESRD) (Kataoka *et al.*, 2012; Cohen *et al.*, 2016; Lu *et al.*, 2015; Wang *et al.*, 2008). Hence, this study evaluates the hypothesis that a combination of high Body Mass Index (BMI) percentile (including both overweight and obese), hypertension (elevated Blood Pressure, BP), and decreased

estimated Glomerular Filtration Rate (eGFR) as measured by plasma clearance of creatinine are associated with liver enlargement (hepatomegaly) and reduced kidney function. This study aimed to determine the relationship between obesity and kidney function with liver size and blood pressure as mediating variables among Mexican American children in South Texas. To better understand the problem, the following research questions were answered:

1. What are the trends of BMI percentile of girls and boys concerning their ages and liver size?
2. Does fatty liver have relationships with BMI percentile and Blood Pressure (BP)?
3. Is there a significant relationship between BMI percentile and liver size?
4. Is there a significant relationship between BMI percentile and hepatomegaly?
5. Is there a significant relationship between BMI percentile and liver size  $\geq 2SD$  (greater than or equal to 2 standard deviations)?
6. Is there a significant relationship between liver size and blood pressure (BP)?
7. What is the relationship between the probability of fatty liver, hepatomegaly, liver size  $\geq 2SD$ , and BMI percentile?
8. Does GFR have relationships to each of the following: BMI percentile, liver size, fatty liver, hepatomegaly, liver size  $\geq 2SD$ , blood pressure, and right kidney volume?
9. Is there a significant relationship between BMI percentile and GFR values with liver size, blood pressure, and right kidney volume as mediating variables?
10. From the variables included in the study, which are the predictors of GFR?

### Review of Literature

Recent studies indicate that obesity has reached epidemic proportions and constitutes a major public health problem (Kitsos *et al.*, 2018; Wang *et al.*, 2008; Kitsos *et al.*, 2018; Wang *et al.*, 2008). Moreover, current research data from the European region suggests that more than half of adults are either overweight (35.7%) or obese (15.9%). Also, the prevalence of obesity affects more than a third of CKD patients and has detrimental effects on kidney structure and function (Kataoka *et al.*, 2012; Kitsos *et al.*, 2018). In the United States, there are approximately 275,000 patients with ESRD, and it is estimated that an additional 8 million US adults have kidney disease (defined as a Glomerular Filtration Rate [GFR] of  $<60$  mL/min per  $1.73$  m<sup>2</sup>) (Kataoka *et al.*, 2012; Khan *et al.*, 2018; Coresh *et al.*, 2003; Fox *et al.*, 2004). Patients with a mildly reduced GFR should be monitored for progression to kidney disease. Because kidney disease often progresses to ESRD and its attendant complications, the identification of precursors of kidney disease is important (Wang *et al.*, 2008).

In a more recent finding, Quintana *et al.* (2018c) predicted in their study using logistic regression that the number of children with the liver disease today may be as high as 24.6 million. They concluded that 'if this trend continues, the adult population with the liver disease could overwhelm the health system in the future and that fatty liver will be the main cause of liver transplant' (Quintana *et al.*, 2018a; Wang *et al.*, 2019). Adibi *et al.* (2017) reported that fatty liver was significantly correlated with BMI ( $r = 0.37$ ,  $p < 0.001$ ) Adibi *et al.* (2017). This finding is also supported by Quintana *et al.* (2018b) that liver size increases for both boys and girls as the child becomes overweight and obese. This relationship holds as the child ages Quintana *et al.* (2018c). Drøyvold *et al.* (2005) found that an increase in BMI and a decrease in BMI were significantly associated with increased and decreased Systolic BP and Diastolic BP Drøyvold *et al.* (2005).

Moreover, Lu *et al.* (2015) reported that there is an association between BMI and reduced kidney function (Lu *et al.*, 2015). This result corroborated the findings of Quintana *et al.* (2018a) that eGFR decreases as age increases for overweight and obese children from age 1 to age 16+ (Quintana *et al.*, 2018b). Duzova *et al.* (2013) also noted the prevalence of hypertension and stage II hypertension, and eGFR were associated with obesity (Duzova *et al.*, 2013). Accumulating clinical evidence also indicates that the presence and severity of nonalcoholic fatty liver disease are associated significantly with CKD (defined as decreased eGFR). Nonalcoholic fatty liver disease predicts the development and progression of CKD (Targher *et al.*, 2014). How do the liver and the kidneys work together? In fat metabolism, the liver cells break down fats and produce energy. They also produce about 800 to 1,000 mL of bile per day. The liver cells convert ammonia to a much less toxic substance called urea, which is released into the blood. Urea is then transported to the kidneys and passes out of the body as urine (IHO, 2016).

According to NIH (2022), BMI is the anthropometric height/weight characteristics in adults (18 years and older). It is used for categorizing them into groups such as: Underweight (slim) =  $<18.5$  kg/m<sup>2</sup>; Normal weight (robust) =  $18.5$ – $24.9$  kg/m<sup>2</sup>; Overweight =  $25$ – $29.9$  kg/m<sup>2</sup>; and Obesity =  $30$  or greater kg/m<sup>2</sup> (Consultation, 2004; Nagai *et al.*, 2013; Nuttall, 2015). It is calculated by dividing an individual mass in kg by the corresponding square of its height in m<sup>2</sup>. It represents an index of an individual's fatness or fitness. It is also widely used as a risk factor for the development of or the prevalence of several health issues (Kataoka *et al.*, 2012; Cohen *et al.*, 2016; Nuttall, 2015; Wang *et al.*, 2008) and is commonly used in determining public health policies (Consultation, 2004; Nuttall, 2015; Wang *et al.*, 2008). Current evidence indicates that there is a wide range of BMIs over which mortality risk is modest (Nuttall, 2015). In this study, the BMI percentile was categorized as follows: 25% as underweight (slim); 26%

– 84% as normal (robust); 85% – 94% as overweight; and  $\geq 95\%$  as obese.

Normally, creatinine is used to evaluate kidney function among elderly patients in clinical practice, which has been reported to be affected by socio-demographic factors like BMI and age (Khan *et al.*, 2018). The concept of proper renal function measurement has been increasing due to the higher prevalence of chronic kidney disease throughout the world (El Nahas and Bello, 2005). The Glomerular Filtration Rate (GFR) is an important parameter to assess renal function using the endogenous marker Serum creatinine (Scr) (Hojs *et al.*, 2006). Many factors affect the efficiency of creatinine to calculate GFR, i.e., age, gender, muscle mass, food intake, and analytic complications associated with evaluation methods. Creatinine is a biological inert by-product of creatine phosphate breakdown in skeletal muscle. The concentration of creatinine in the body is mostly dependent on muscle mass and up to some extent on diet as well. Generally, the creatinine range increases from the normal level only after a decline in GFR of  $\leq 50$  mL/min/1.73 m<sup>2</sup> (Khan *et al.*, 2018). Kidney function is proportional to kidney size, which is proportional to body surface area. A body surface area of 1.73 m<sup>2</sup> is the normal mean value for young adults. Adjustment for body surface area is necessary when comparing a patient's estimated GFR to normal values or the levels defining the stages of CKD (NKF, 2017).

Results reveal that equations for the creatinine-based estimated Glomerular Filtration Rate (eGFR) were recently established for Japanese adults (18 years old) and children (2–11 years old), respectively, but it is unclear whether eGFR can be as useful as 24-h Creatinine Clearance (CCr) for assessing renal function in patients receiving chemotherapy (Fox *et al.*, 2004; Imai *et al.*, 2007; Nuttall, 2015; Inoue *et al.*, 2015).

The global mean (95%) prevalence of CKD in five stages was 13.4% (11.7-15.1%) and from stages three to five 10.6% (9.2–12.2%) (Hill *et al.*, 2016). The stages of CKD is well-established by the (VHA, 2009) and they are as follows: Stage 1-kidney damage with normal eGFR  $\geq 90$ -mL/min/1.73 m<sup>2</sup>; Stage 2-kidney damage with mildly decreased eGFR = 60-89 mL/min/1.73 m<sup>2</sup>; Stage 3-kidney damage with moderately decreased eGFR 30-59-mL/min/1.73 m<sup>2</sup>; Stage 4-kidney damage with severely decreased eGFR 15-29 mL/min/1.73 m<sup>2</sup>; Stage 5-kidney failure eGFR  $< 15$  mL/min/1.73 m<sup>2</sup> (PCV, 2009; USRDS, 2002). A BMI of 30 kg/m<sup>2</sup> or more is associated with rapid loss of kidney function in patients with eGFR of at least 60 mL/min per 1.73 m<sup>2</sup>, and this association is accentuated in older patients. A BMI of 35 kg/m<sup>2</sup> or more is also associated with high mortality. A BMI of at least 25 kg/m<sup>2</sup> but less than 30 kg/m<sup>2</sup> is associated with the best clinical outcomes (Lu *et al.*, 2015). Therefore, policies should be

developed to encourage the young population to stay within the appropriate BMI percentile or category.

Hence, this study was conducted to determine the relationships, trends, and predictability of the effects of BMI on the occurrence of liver disease and the quality of kidney function using the plasma clearance of creatinine. It also evaluated the effects of BMI, liver size, blood pressure, and right kidney volume on chronic liver enlargement and kidney function.

## Materials and Methods

The data in this study were obtained from a South Texas pediatric clinic. The Institutional Review Board (IRB) at Texas A&M International University (TAMU) has approved the research before obtaining data from the pediatric clinic. The clinical records from 763 children visiting a South Texas pediatric clinic from 2003 to 2018 were assessed. Data mining was performed to determine trends on the effects of BMI percentile, liver size, blood pressure, and right kidney volume on the prevalence of chronic liver enlargement and kidney disease progression.

Statistical analyses were performed using the IBM Statistical Package for the Social Sciences (SPSS). Descriptive statistics were employed to determine the characteristics of the subjects. Associations for continuous measures were evaluated using Pearson Product Moment Correlation, whereas Spearman's Rho Correlation for ordinal or categorical variables. Linear regression was used to find out the relationship of continuous variables such as BMI percentile, liver size, blood pressure, and right kidney volume on GFR. Binary logistic regression was employed to determine the probability of fatty liver, hepatomegaly, and liver size  $\geq 2$  SD concerning BMI percentile. Path analysis and factor analysis were also performed to find out the effect of BMI percentile, liver size, blood pressure, and right kidney volume on GFR. Statistical significance was defined as a two-sided  $p \leq 0.05$  or lower.

## Results and Discussion

The subsequent data summarizes the results of the study. The results are presented as follows: (1) Characteristics of the subjects using liver size vs. BMI percentile and age, and (2) Relationships between BMI percentile, liver size, blood pressure, and right kidney volume on liver enlargement and GFR.

Characteristics of the subjects. Figure 1 compares liver size by age between boys and girls. The figure shows that liver size in boys increases faster ( $\beta = 0.327$ ) than the liver size in girls ( $\beta = 0.240$ ). At the same age, boys have larger liver sizes than girls. Figure 2 compares liver size by age among underweight (slim), normal (robust), overweight, and obese boys. The liver size of overweight ( $\beta = 0.439$ ) and underweight ( $\beta = 0.460$ ) boys increases with age almost at the same rate.

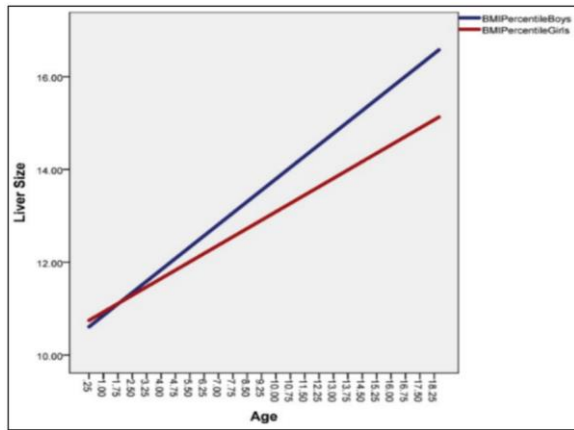

**Fig. 1:** Comparison of liver size between boys and girls by age

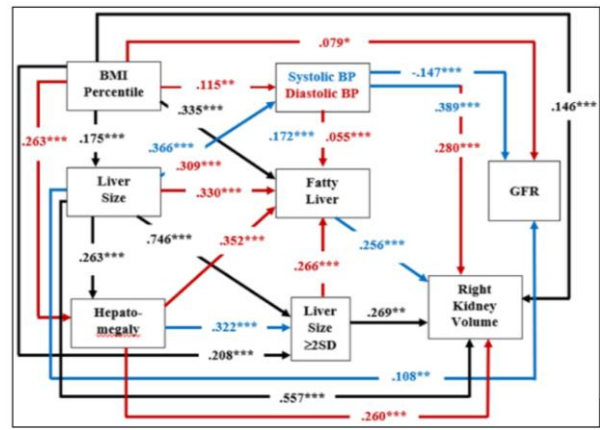

**Fig. 4:** Path analysis of the predictors of liver enlargement and reduced GFR

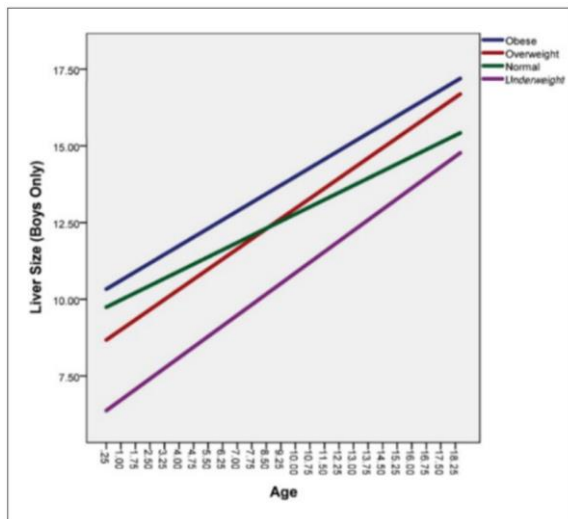

**Fig. 2:** Comparison of liver size among underweight, normal, overweight, and obese boys by age

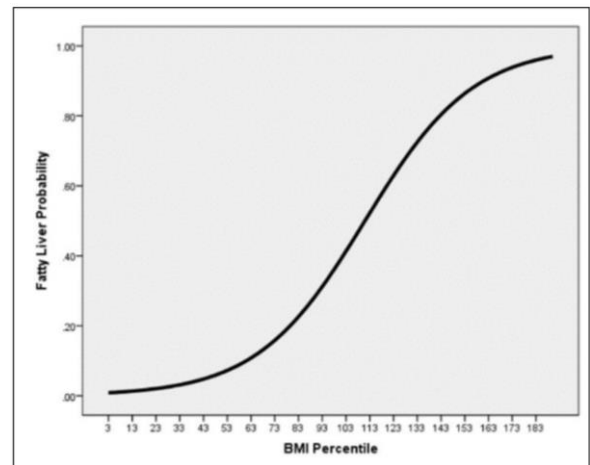

**Fig. 5:** Fatty liver probability vs. BMI percentile for boys and girls

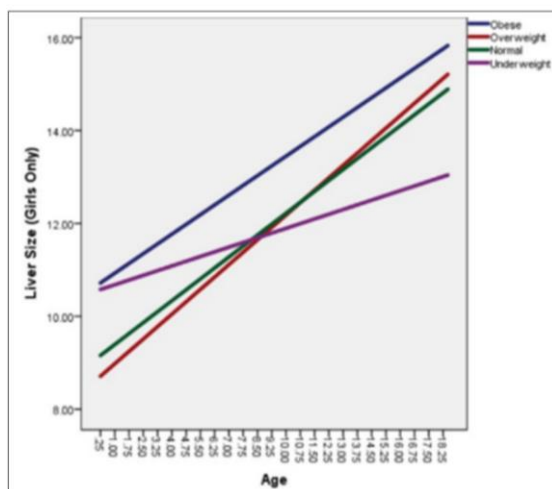

**Fig. 3:** Comparison of liver size among underweight, normal, overweight, and obese girls by age

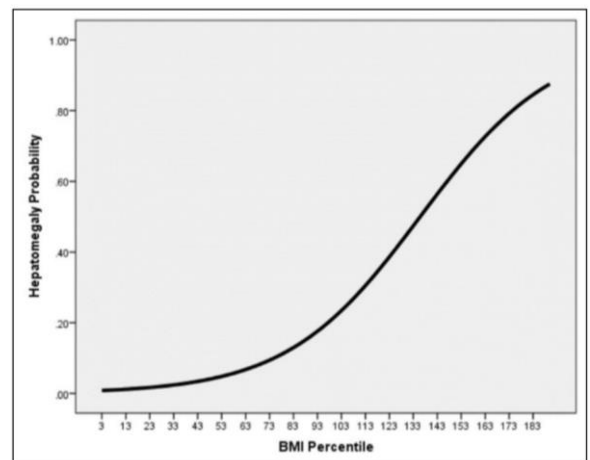

**Fig. 6:** Hepatomegaly vs. BMI percentile for boys and girls

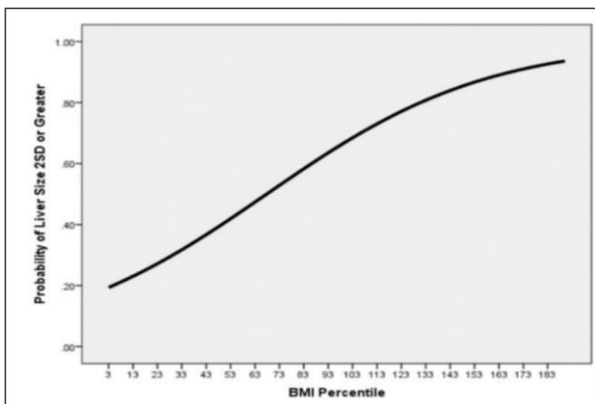

**Fig. 7:** Liver size  $\geq 2SD$  probability vs BMI percentile for boys and girls

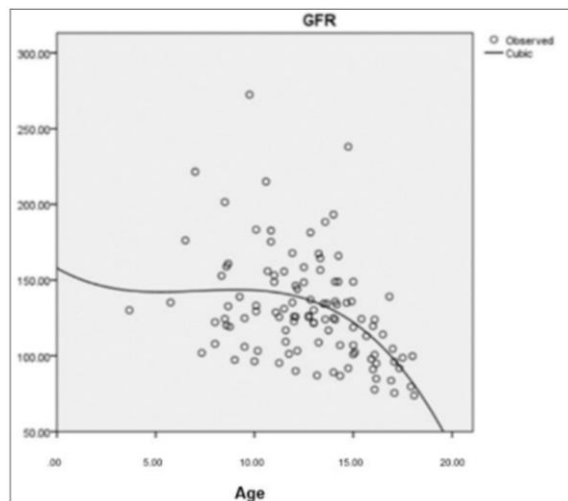

**Fig. 10:** Cubic estimation of the overweight boys and girls

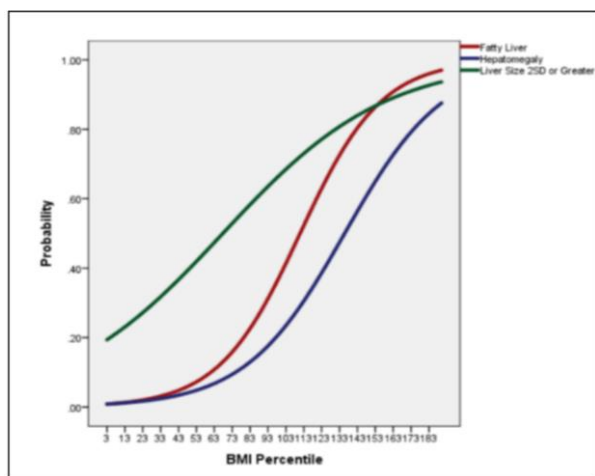

**Fig. 8:** Comparison of Fatty liver, Hepatomegaly and Liver size  $\geq 2SD$  probabilities vs. BMI percentile for boys and girls

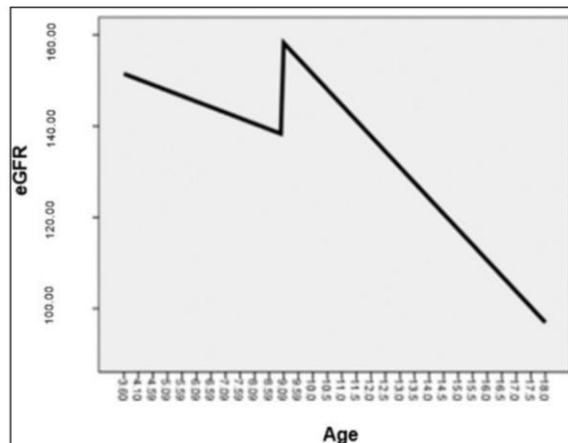

**Fig. 11:** eGFR vs. Age of overweight boys and girls

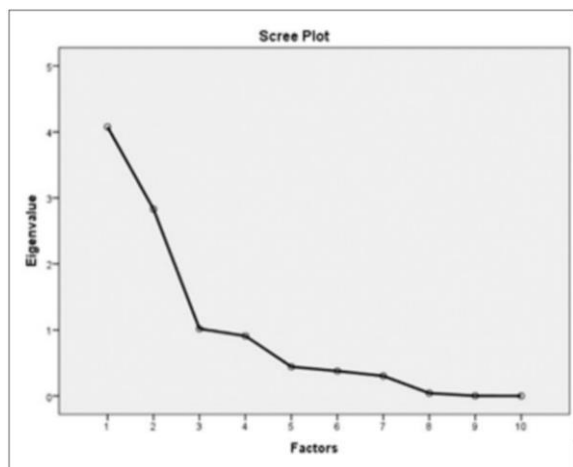

**Fig. 9:** Predictive factors of GFR for boys and girls

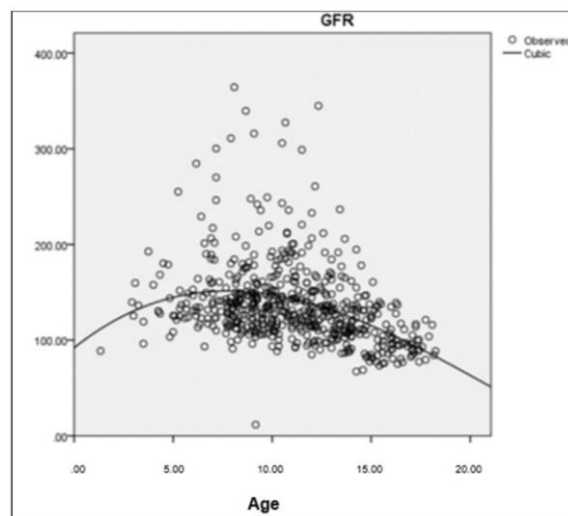

**Fig. 12:** Cubic estimation of the obese boys and girls

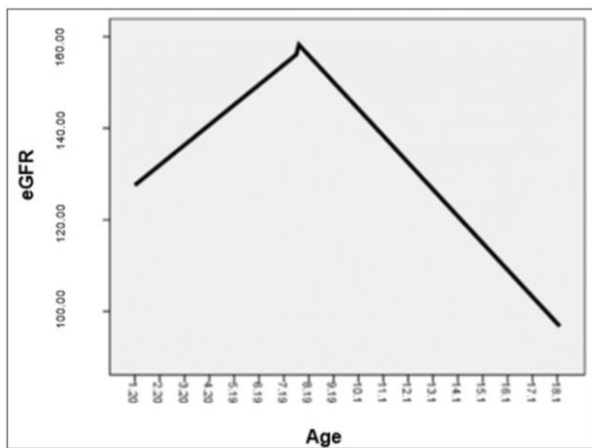

**Fig. 13:** eGFR vs. Age of obese boys and girls

However, the liver size of obese ( $\beta = 0.376$ ) boys increases with age more slowly than the liver size of overweight and underweight boys. The liver size of normal (robust) boys increases with age at a much slower rate ( $\beta = 0.311$ ) compared with the other three categories. Between 8 to 9 years old, the normal and overweight boys have similar liver sizes. After this age range, overweight boys have larger liver sizes than normal boys. Obese boys have the largest liver size at any age. Figure 3 compares liver size by age among underweight (slim), normal (robust), overweight, and obese girls. Underweight ( $\beta = 0.135$ ) girls have a slower increase rate in liver size as compared to the normal ( $\beta = 0.314$ ), overweight ( $\beta = 0.356$ ), and obese ( $\beta = 0.280$ ) girls. Liver size is larger for obese girls when compared with normal and overweight girls. Between 10 to 12 years old, normal and overweight girls have similar liver sizes. After this age range, overweight girls have larger liver sizes than normal girls. Similar conclusion as we had for boys, obese girls have the largest liver size at any age.

Relationships between BMI percentile, liver size, blood pressure, and right kidney volume on liver condition and GFR. The following results present the degree of relationship between BMI percentile and the other predictors of liver enlargement and reduced GFR.

Figure 4 reveals that fatty liver has a relationship with BMI percentile and blood pressure. BMI percentile has a direct positive relationship of 0.355 ( $p < 0.001$ ) on fatty liver and 0.115 ( $p < 0.01$ ) on diastolic blood pressure but not on systolic blood pressure. Systolic blood pressure has a positive direct effect of 0.172 ( $p < 0.001$ ) while diastolic blood pressure has also a direct effect of 0.055 ( $p < 0.001$ ) on fatty liver. This result suggests that BMI percentile has a direct effect on the fatty liver with systolic and diastolic blood pressure as the mediating variables. Figure 4 also shows that BMI percentile has significant relationships with liver size ( $r = 0.175$ ;  $p < 0.001$ ), hepatomegaly ( $r = 0.263$ ;  $p < 0.001$ ), and liver size  $\geq 2SD$  ( $r = 0.208$ ;  $p < 0.001$ ). Liver size has significant relationships with hepatomegaly ( $r = 0.263$ ;

$p < 0.001$ ), fatty liver ( $r = 0.330$ ;  $p < 0.001$ ), liver size  $\geq 2SD$  ( $r = 0.746$ ;  $p < 0.001$ ), systolic blood pressure ( $r = 0.366$ ;  $p < 0.001$ ), diastolic blood pressure ( $r = 0.309$ ;  $p < 0.001$ ), and right kidney volume ( $r = 0.557$ ;  $p < 0.001$ ).

Figure 5, 6 and 7 show the results on the probability of fatty liver, probability of hepatomegaly and probability of liver size  $\geq 2SD$  vs. BMI percentile and they are given as follows: (a) Boys' and girls' logistic regression of fatty liver vs. BMI percentile ( $n = 763$ ,  $\alpha = -4.882$ , Wald = 43.816,  $df = 1$ ,  $p < 0.001$ ;  $\beta = 0.044$ , Wald = 33.62,  $df = 1$ ,  $p < 0.001$ ), (b) boys' and girls' logistic regression of hepatomegaly vs. BMI percentile ( $n = 763$ ,  $\alpha = -4.891$ , Wald = 41.354,  $df = 1$ ,  $p < 0.001$ ;  $\beta = 0.036$ , Wald = 22.166,  $df = 1$ ,  $p < 0.001$ ), (c) boys' and girls' logistic regression of liver size  $\geq 2SD$  vs. BMI percentile ( $n = 763$ ,  $\alpha = -1.491$ , Wald = 14.119,  $df = 1$ ,  $p < 0.001$ ;  $\beta = 0.022$ , Wald = 28.381,  $df = 1$ ,  $p < 0.001$ ).

Figure 5 describes the probability of fatty liver for boys and girls by BMI percentile. The results mentioned above reveal that the probability of fatty liver increases exponentially as the BMI percentile increases. Figure 6 illustrates the probability of hepatomegaly for boys and girls by BMI percentile. The probability of hepatomegaly increases exponentially with BMI percentile. Figure 7 demonstrates the probability of liver size  $\geq 2SD$  for boys and girls by BMI percentile. The probability of liver size  $\geq 2SD$  increases exponentially as the BMI percentile increases. Figure 8 compares the probabilities of fatty liver, hepatomegaly, and liver size  $\geq 2SD$  vs. BMI percentile for both boys and girls. Results show that the liver becomes fatty first before it gets larger than 2SD. The midpoint of Fig. 5, 6, and 7 are the points of inflections. Keeping all other factors constant, the additional probability of fatty liver, probability of hepatomegaly, and probability of liver size  $\geq 2SD$  gained by another one unit increase of the BMI percentile will eventually be smaller than the additional probabilities gained by the previous increase in BMI percentile.

Figure 4 also discloses that GFR has a positive relationship with BMI percentile of 0.079 ( $p < 0.05$ ) but has a negative relationship of 0.147 ( $p < 0.001$ ) with systolic blood pressure. GFR has also a negative relationship of 0.108 ( $p < 0.01$ ) with liver size. This implies that increased systolic BP and larger liver size correspond to lower GFR. Furthermore, although the right kidney volume has relationships with BMI percentile ( $r = 0.146$ ;  $p < 0.001$ ), systolic blood pressure ( $r = 0.389$ ;  $p < 0.001$ ), diastolic blood pressure ( $r = 0.280$ ;  $p < 0.001$ ), liver size ( $r = 0.557$ ;  $p < 0.001$ ), liver size  $\geq 2SD$  ( $r = 0.269$ ;  $p < 0.001$ ), hepatomegaly ( $r = 0.260$ ;  $p < 0.001$ ), and fatty liver ( $r = 0.256$ ;  $p < 0.001$ ), the right kidney volume has no significant relationship with GFR. Also, fatty liver, hepatomegaly, and liver size  $\geq 2SD$  have no significant relationships with GFR. This implies that right kidney volume is affected by BMI percentile, systolic BP, diastolic BP, liver size, liver size  $\geq 2SD$ , hepatomegaly, and

fatty liver. However, GFR is not affected by the right kidney volume. Only BMI percentile, systolic blood pressure, and liver size have a direct effect on the reduction of GFR. This indicates that kidney function is affected by BMI percentile, liver size, and systolic blood pressure.

Let us look again at the probability results in Fig. 8 and the path analysis in Fig. 4. On one hand, Fig. 8 shows that the probability of fatty liver, probability of hepatomegaly, and probability of liver size  $\geq 2SD$  increase with BMI percentile for boys and girls. On the other hand, Fig. 4 path analysis reveals that there are significant relationships between liver size and fatty liver ( $r = 0.330$ ;  $p < 0.001$ ); between liver size and hepatomegaly ( $r = 0.263$ ;  $p < 0.001$ ); between liver size and liver size  $\geq 2SD$  ( $r = 0.746$ ;  $p < 0.001$ ); between hepatomegaly and liver size  $\geq 2SD$  ( $r = 0.322$ ;  $p < 0.001$ ); between liver size and fatty liver ( $r = 0.266$ ;  $p < 0.001$ ); between BMI percentile and liver size ( $r = 0.175$ ;  $p < 0.001$ ); between BMI percentile and hepatomegaly ( $r = 0.263$ ;  $p < 0.001$ ); between BMI percentile and liver size  $\geq 2SD$  ( $r = 0.208$ ;  $p < 0.001$ ); between BMI percentile and fatty liver ( $r = 0.335$ ;  $p < 0.001$ ); and between BMI percentile and right kidney volume ( $r = 0.146$ ;  $p < 0.001$ ). These results corroborate each other that liver size, hepatomegaly, fatty liver, and liver size  $\geq 2SD$  are affected by BMI percentile. As the child ages with increasing BMI percentile, their corresponding liver size, hepatomegaly, fatty liver, and liver size  $\geq 2SD$  increases as well.

Figure 9 and the probability results (Fig. 5, 6, 7, 8) together with the path analysis (Fig. 4) confirm the three factors affecting GFR using factor analysis. The Scree Plot reveals that there are three factors (components) affecting GFR as shown by the eigenvalues greater than or equal to 1. Figure 10 is an Equamax Rotated Matrix of the predictor variables for GFR. The first component shows that there are significant relationships between BMI percentile ( $r = 0.994$ ) and probabilities of fatty liver ( $r = 0.993$ ), hepatomegaly ( $r = 0.990$ ), and liver size  $\geq 2SD$  ( $r = 0.994$ ). The second component displays that there are significant relationships between liver size ( $r = 0.714$ ) and age ( $r = 0.721$ ) together with right kidney volume ( $r = 0.752$ ), systolic ( $r = 0.783$ ) and diastolic ( $r = 0.738$ ) BP. The third component exhibits that GFR ( $r = 0.921$ ) is an important factor that relates to the earlier components. The results of the factor analysis confirm the results of the path analysis and the probability results that the three factors affecting GFR include BMI percentile, liver size, and blood pressure with age as mediating variables. Therefore, high BMI percentile, increased liver size, and increased systolic blood pressure are precursors (predictors) to decreased kidney function. Hence, the predictive model function of:

$$GFR = 198.632 + [0.208 * BMI \text{ percentile}] - [1.682 * liver \text{ size}] - [0.538 * systolic \text{ BP}] \quad (1)$$

In Eq. 1, all the predictors have a significant effect on GFR such as BMI percentile ( $p < 0.01$ ), liver size ( $p < 0.05$ ),

and systolic BP ( $p = 0.001$ ). This model suggests that for all young (overweight and obese) individuals, their GFR decreases with a high BMI percentile along with liver enlargement and increased systolic BP.

Cognizant of the effect of BMI percentile on kidney function, it is imperative to determine the age of obese and overweight children with decreased GFR. A cubic curve was fitted between GFR vs. age for the obese and overweight categories of boys and girls to determine the age that GFR values start to decrease. Figure 10 shows the cubic estimation of overweight boys and girls. Figure 11 reveals that eGFR starts to decrease at age 9.185 for overweight children. Figure 12 shows the cubic estimation of obese boys and girls. Figure 13 describes that eGFR starts to decrease at age of 7.755 for obese children. These results show that obese children have a higher prevalence of reduced kidney function at an earlier age than overweight children. These same results reveal that there is a significant effect of age as a mediating variable in kidney function. Hence, the corrected predictive model function of:

$$GFR = 169.126 - [0.117 * BMI \text{ percentile}] + [2.648 * liver \text{ size}] + [0.025 * systolic \text{ BP}] - [5.542 * Age] \quad (2)$$

In Eq. 2, the only significant predictors of GFR are age ( $p < 0.001$ ) and liver size ( $p < 0.01$ ). This suggests that for all young (overweight and obese) individuals, their GFR decreases with age along with liver enlargement.

## Conclusion

The results of the correlations, generalized regression, logistic regression analyses in this study reveal that: (a) Boys have bigger liver size than girls do; (b) Obese and overweight boys and girls have bigger liver size than normal (robust) and underweight (slim) boys and girls do; (c) There is a significant relationship ( $r = 0.335$ ;  $p < 0.001$ ) between BMI percentile and fatty liver for a combined population of boys and girls; (d) there is a significant relationship ( $r = 0.263$ ;  $p < 0.001$ ) between BMI percentile and hepatomegaly for a combined population of boys and girls; (e) There is a significant relationship ( $r = 0.208$ ;  $p < 0.001$ ) between BMI percentile and liver size  $\geq 2SD$  for a combined population of boys and girls; (f) There is a significant relationship ( $r = 0.175$ ;  $p < 0.001$ ) between BMI percentile and liver size for a combined population of boys and girls; (g) There is a significant relationship ( $r = 0.115$ ;  $p < 0.01$ ) between BMI percentile and diastolic blood pressure for a combined population of boys and girls. Reported that fatty liver was significantly correlated with BMI ( $r = 0.37$ ;  $p < 0.001$ ) (Adibi *et al.*, 2017). This finding is also supported by Quintana *et al.* (2018c) that liver size increases for both boys and girls as the child becomes overweight and obese. This relationship holds as the child ages (Quintana *et al.*, 2018a; Drøyvold *et al.*, 2005). Found that an increase in BMI and a

decrease in BMI were significantly associated with increased and decreased Systolic BP and Diastolic BP (Drøyvold *et al.*, 2005).

Moreover, the liver size probability results together with path analysis and factor analysis reveal confirmatory findings that the BMI percentile, liver size, and systolic BP are factors affecting GFR. Liver size, systolic BP, and age as mediating variables. As BMI percentile increases in boys and girls, their liver size increases, and this relationship is maintained as the child ages. Therefore, high BMI percentile, increased liver size, and increased systolic blood pressure are precursors (predictors) to decreased kidney function. Lu *et al.* (2015) reported that there is an association between BMI and reduced kidney function (Lu *et al.*, 2015). This result corroborated the findings of Quintana *et al.* (2018b) that eGFR decreases as age increases for overweight and obese children from age 1 to age 16+ (Quintana *et al.*, 2018c). Duzova *et al.* (2013) also noted the prevalence of hypertension and stage II hypertension, and eGFR were associated with obesity (Duzova *et al.*, 2013). In a nutshell, the Department of Health and Human Services should develop strategies for the prevention and management of overweight and obesity in children. Such critical action would lessen the escalating health issues of chronic liver enlargement and reduced kidney function among young Americans.

## Acknowledgment

Use the same font size for the content of the acknowledgments section.

The authors wish to acknowledge Dr. Francisco J. Cervantes-Gonzalez for gathering the data for analysis. The abstract of this study was presented at the TAMU LBV Conference in Fall 2019.

## Funding Information

The authors should acknowledge the funders of this manuscript and provide all necessary funding information. The Laredo Pediatrics and Neonatology PA collected and provided all data for analysis.

## Author's Contributions

**Orlando Patricio:** Designed and performed the statistical analysis, wrote the initial and reviewed the manuscript.

**Rohitha Goonatilake:** Verified the statistical analysis, reviewed and edited the manuscript.

**Fernando G. Quintana:** Conceptualized and coordinated the data collection, analyzed and reviewed the manuscript.

**Hongwei Wang:** Supervised together with Fernando Quintana the statistical analysis of the data, reviewed and prepared the final manuscript.

**Francisco Cervantes-Gonzalez:** Created the data collection tool, collected data, and reviewed the manuscript.

## Ethics

The authors should address any ethical issues that may arise after the publication of this manuscript.

## References

- Adibi, A., Maleki, S., Adibi, P., Etmnani, R., & Hovsepian, S. (2017). Prevalence of nonalcoholic fatty liver disease and its related metabolic risk factors in Isfahan, Iran. *Advanced Biomedical Research*, 6.  
<https://doi.org/10.4103/2277-9175.204590>
- Cohen, J. B., Stephens-Shields, A. J., Denburg, M. R., Anderson, A. H., Townsend, R. R., & Reese, P. P. (2016). Obesity, renin-angiotensin system blockade and risk of adverse renal outcomes: A population-based cohort study. *American Journal of Nephrology*, 43(6), 431-440.  
<https://doi.org/10.1159/000446862>
- Consultation, W. E. (2004). Appropriate body-mass index for Asian populations and its implications for policy and intervention strategies. *Lancet (London, England)*, 363(9403), 157-163.  
[https://doi.org/10.1016/S0140-6736\(03\)15268-3](https://doi.org/10.1016/S0140-6736(03)15268-3)
- Coresh, J., Astor, B. C., Greene, T., Eknoyan, G., & Levey, A. S. (2003). Prevalence of chronic kidney disease and decreased kidney function in the adult US population: Third National Health and Nutrition Examination Survey. *American Journal of Kidney Diseases*, 41(1), 1-12.  
<https://doi.org/10.1053/ajkd.2003.50007>
- Drøyvold, W. B., Midthjell, K., Nilsen, T. I. L., & Holmen, J. (2005). Change in body mass index and its impact on blood pressure: A prospective population study. *International Journal of Obesity*, 29(6), 650-655.  
<https://doi.org/10.1038/sj.ijo.0802944>
- Duzova, A., Yalçinkaya, F., Baskin, E., Bakkaloglu, A., & Soylemezoglu, O. (2013). Prevalence of hypertension and decreased glomerular filtration rate in obese children: Results of a population-based field study. *Nephrology Dialysis Transplantation*, 28(suppl\_4), iv166-iv171.x  
<https://doi.org/10.1093/ndt/gft317>
- El Nahas, A. M., & Bello, A. K. (2005). Chronic kidney disease: The global challenge. *The Lancet*, 365(9456), 331-340.  
[https://doi.org/10.1016/S0140-6736\(05\)17789-7](https://doi.org/10.1016/S0140-6736(05)17789-7)
- Fox, C. S., Larson, M. G., Leip, E. P., Culleton, B., Wilson, P. W., & Levy, D. (2004). Predictors of new-onset kidney disease in a community-based population. *Jama*, 291(7), 844-850.  
<https://doi.org/10.1001/jama.291.7.844>



- Hill, N. R., Fatoba, S. T., Oke, J. L., Hirst, J. A., O'Callaghan, C. A., Lasserson, D. S., & Hobbs, F. R. (2016). The global prevalence of chronic kidney disease—a systematic review and meta-analysis. *PLoS One*, *11*(7), e0158765. <https://doi.org/10.1371/journal.pone.0158765>
- Hojs, R., Bevc, S., Ekart, R., Gorenjak, M., & Puklavec, L. (2006). Serum cystatin C is an endogenous marker of renal function in patients with mild to moderate impairment of kidney function. *Nephrology Dialysis Transplantation*, *21*(7), 1855-1862. <https://doi.org/10.1093/ndt/gfl073>
- IHO. (2016). Institute for Quality and Efficiency in Health Care (IQWiG) Version: Informed Health Online [Internet] August 22, 2016 PMID: PMH0072577 <https://www.ncbi.nlm.nih.gov/pubmed/health/PMH0072577/>
- Imai, E., Horio, M., Nitta, K., Yamagata, K., Iseki, K., Hara, S., ... & Matsuo, S. (2007). Estimation of glomerular filtration rate by the MDRD study equation modified for Japanese patients with chronic kidney disease. *Clinical and Experimental Nephrology*, *11*(1), 41-50. <https://doi.org/10.1007/s10157-006-0453-4>
- Inoue, N., Watanabe, H., Okamura, K., Kondo, S., & Kagami, S. (2015). Are the equations for the creatinine-based estimated glomerular filtration rate applicable to the evaluation of renal function in Japanese children and adult patients receiving chemotherapy? *Clinical and Experimental Nephrology*, *19*(2), 298-308. <https://doi.org/10.1007/s10157-014-0976-z>
- Kataoka, H., Ohara, M., Shibui, K., Sato, M., Suzuki, T., Amemiya, N., ... & Nitta, K. (2012). Overweight and obesity accelerate the progression of IgA nephropathy: Prognostic utility of a combination of BMI and histopathological parameters. *Clinical and Experimental Nephrology*, *16*(5), 706-712. <https://doi.org/10.1007/s10157-012-0613-7>
- Khan, I., Khan, A. H., Adnan, A. S., Sulaiman, S. A. S., Hamzah, A. B. A., Ahmed, N., & Khan, A. (2018). Effect of sociodemographic factors on endogenous biomarkers (cystatin C and creatinine) among elderly chronic kidney disease patients: a cross-sectional study. *International Urology and Nephrology*, *50*(6), 1113-1121. <https://doi.org/10.1007/s11255-018-1834-9>
- Kitsos, A., Dounousi, E., Kalaitzidis, R., Challa, A., Siamopoulos, K. C., & Tigas, S. (2018). Serum vitamin D in obese and overweight subjects according to estimated glomerular filtration rate. *Hormones*, *17*(2), 237-246. <https://doi.org/10.1007/s42000-018-0022-8>
- Lu, J. L., Molnar, M. Z., Naseer, A., Mikkelsen, M. K., Kalantar-Zadeh, K., & Kovesdy, C. P. (2015). Association of age and BMI with kidney function and mortality: A cohort study. *The Lancet Diabetes & Endocrinology*, *3*(9), 704-714. [https://doi.org/10.1016/S2213-8587\(15\)00128-X](https://doi.org/10.1016/S2213-8587(15)00128-X)
- Nagai, T., Uemura, O., Ishikura, K., Ito, S., Hataya, H., Gotoh, Y., ... & Honda, M. (2013). Creatinine-based equations to estimate glomerular filtration rate in Japanese children aged between 2 and 11 years old with chronic kidney disease. *Clinical and Experimental Nephrology*, *17*(6), 877-881. <https://doi.org/10.1007/s10157-013-0799-3>
- NIH. (2022). National Institute of Diabetes and Digestive and Kidney Diseases. *BMI Categories*. <https://www.niddk.nih.gov/health-information/health-statistics/overweight-obesity>
- NKF. (2017). FAQs About GFR Estimates. *National Kidney Foundations*.
- Nuttall, F. Q. (2015). Body mass index: obesity, BMI, and health: A critical review. *Nutrition Today*, *50*(3), 117. DOI.org/10.1097/NT.0000000000000092
- PCV. (2009). Primary Care of Veterans with HIV. Office of Clinical Public Health Programs.
- VHA. (2009). National Kidney Foundation: Stages of Chronic Kidney Disease (based on eGFR). <https://www.hiv.va.gov/pdf/pcm-manual.pdf>
- Quintana, F. G., Cadena, J. A., & Cervantes-Gonzalez, F. J. (2018a). Obesity and Liver Function in a Group of Children Visiting a Pediatric Clinic in South Texas. *Diabetes*, *67*(Supplement\_1). <https://doi.org/10.2337/db18-2462-PUB>
- Quintana, F. G., Cervantes-Gonzalez, F. J., & Wang, H. (2018b). Measurement of Liver Size by Imaging Methods Unveils Fatty Liver and Hepatomegaly in Overweight Mexican-American Children. *Diabetes*, *67*(Supplement\_1). <https://doi.org/10.2337/db18-294-LB>
- Quintana, F. G., Wang, H., Cervantes-Gonzalez, F. J., & Perez, M. A. (2018c). eGFR changes in overweight/obese Mexican-American children. *Diabetes*, *67* (Supplement\_1). <https://doi.org/10.2337/db18-2461-PUB>
- Targher, G., Chonchol, M. B., & Byrne, C. D. (2014). CKD and nonalcoholic fatty liver disease. *American Journal of Kidney Diseases*, *64*(4), 638-652. <https://doi.org/10.1053/j.ajkd.2014.05.019>
- USRDS. (2002). US Renal Data System, Annual Data Report: Atlas of End-Stage Renal Disease in the United States. (2002). Bethesda, Md: National Institutes of Health, National Institute of Diabetes and Digestive and Kidney Diseases.
- Wang, H., Quintana, F. G., Cervantes, F. J., & Faz, M. (2019). Analysis of the Relationship among Kidney Volume, Obesity, and Blood Pressure in Mexican-American Children. *Journal of Pediatric Nephrology*, *7*(3), 1-7. <https://doi.org/10.22037/jpn.v7i3.26495>
- Wang, Y., Chen, X., Song, Y., Caballero, B., & Cheskin, L. J. (2008). Association between obesity and kidney disease: A systematic review and meta-analysis. *Kidney International*, *73*(1), 19-33. <https://doi.org/10.1038/sj.ki.5002586>